

NUMBER C-179609



METRIC

DIMENSIONS IN MILLIMETERS. DO NOT SCALE PRINT

PRINT DIST

MATE 0.6 DIA POST
Ø0.6ポストと嵌合

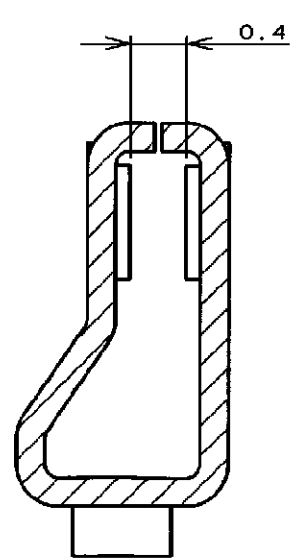
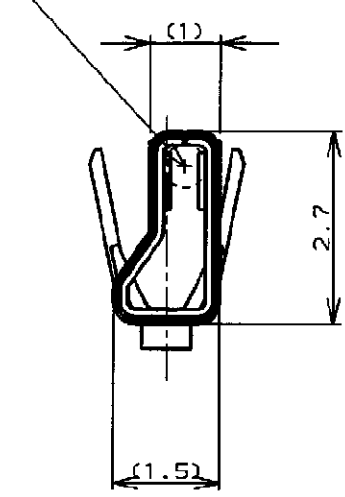

SECT "C" - "C"
(SCALE 20-1)

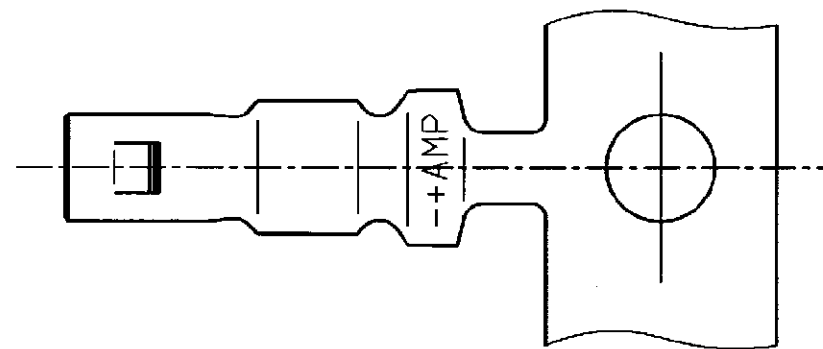
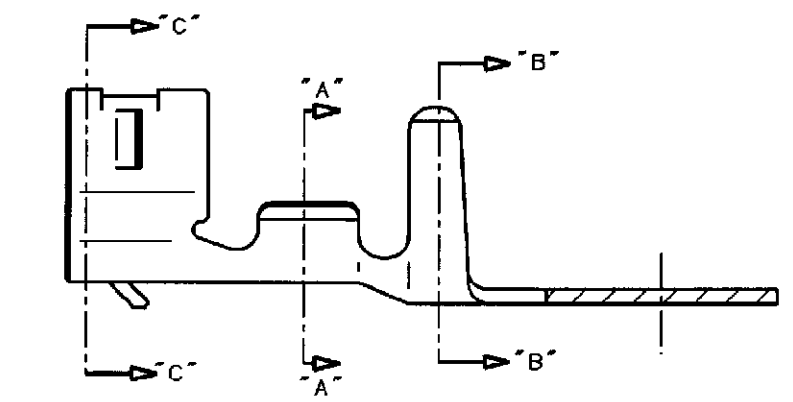
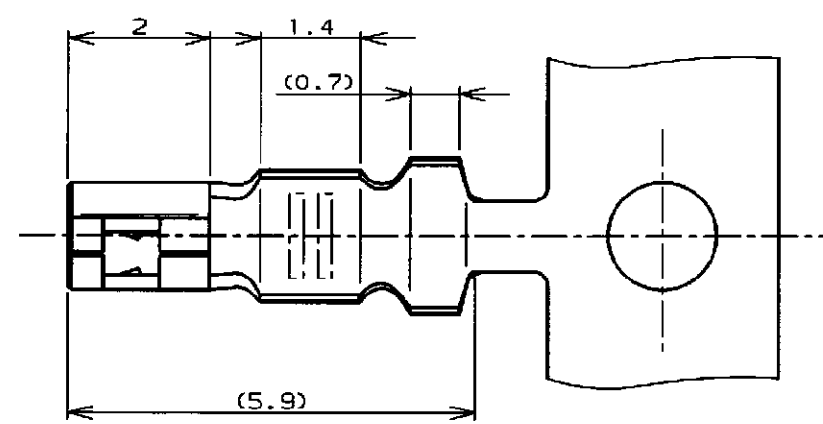

SECT "A" - "A"

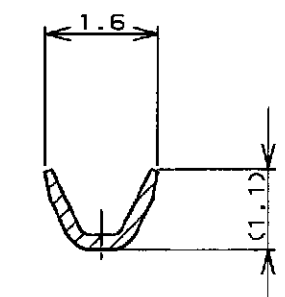

SECT "B" - "B"

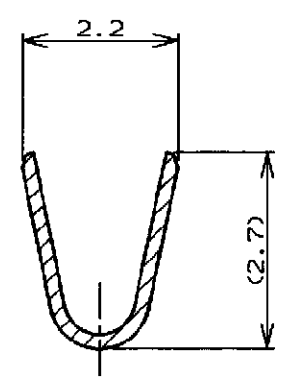

注:

1. 使用ハウジングは型番 179228
2. 製品規格: 108-5408
3. 取付適用規格: 114-5179

NOTES,

1. USE HOUSING ; P/N 179228
2. PRODUCT SPEC ; 108-5408
3. APPLICATION SPEC ; 114-5179

PRE-TINNED PHOSPHOR BRONZE (0.2t) 錫めっき赤磷黄銅、(板厚0.2)	179609-1
MATERIAL & FINISH 材質	PART NO. 型番

Copyright ©19 年 日本アンプ株式会社	Copyright ©19 年 AMP (Japan), LTD. ALL RIGHTS RESERVED.	AMP	AMP (JAPAN), LTD. Kawasaki, Japan
------------------------------	--	------------	--------------------------------------

WIRE RANGE 0.05 ~0.12 mm ² (AWG30-25)		INSULATION DIA 0.65-1.35 mmφ		NAME 圧着タイプIIリセコンタクト CRIMP TYPE II RECEPTACLE CONTACT (AMP CT CONNECTOR 2mm PITCH)				
MATERIAL 表参照		FINISH 表参照		GENERAL TOLERANCE		SIZE	LOC	NUMBER
DR. T. FURUYA		DE. T. FURUYA		0<≦10 : ±0.2 10<≦30 : ±0.25 30<≦100 : ±0.3		B	J	C-179609
CHK. S. KUBOUCHI		APP. S. Kubouchi		ANGLES : ±3°		SCALE	REV.	SHEET
LTR REVISION RECORD		DR CHK DATE		10-1		10-1	B1	1 OF 1